

McIntosh
MC 2120

OWNER'S MANUAL

THE MCINTOSH MC 2120 SOLID STATE STEREO POWER AMPLIFIER



Reading Time: 29 Minutes

Price \$1.25

Your MC 2120 Stereo Power Amplifier will give you many years of pleasant and satisfactory performance. If you have any questions, please contact:

CUSTOMER SERVICE

McIntosh Laboratory Inc.
2 Chambers Street
Binghamton, New York 13903
Phone: 607-723-3512

WARNING: TO PREVENT FIRE OR SHOCK HAZARD, DO NOT EXPOSE THIS UNIT TO RAIN OR MOISTURE.

Take Advantage of 3 years
of FREE Service ...
Fill in the Application NOW.

Contents

SERVICE	1
INSTALLATION	2
HOW TO CONNECT	4
FRONT PANEL INFORMATION	8
REAR PANEL INFORMATION	10
PERFORMANCE LIMITS AND RATINGS	11
PERFORMANCE CHARTS	12
TECHNICAL DESCRIPTION	14
BLOCK DIAGRAM	16

THREE YEAR SERVICE CONTRACT

An application for a FREE THREE YEAR SERVICE CONTRACT is included with this manual.

The terms of the contract are:

1. McIntosh will provide all parts, materials and labor needed to return the measured performance of the instrument to the original performance limits free of any charge. The SERVICE CONTRACT does not cover any shipping costs to and from the authorized service agency or the factory.
2. Any McIntosh authorized service agency will repair all McIntosh instruments at normal service rates. To receive the free service under the terms of the SERVICE CONTRACT, the SERVICE CONTRACT CERTIFICATE must accompany the instrument when taken to the service agency.
3. Always have service done by a McIntosh authorized service agency. If the instrument is modified or damaged, as a result of unauthorized repair the SERVICE CONTRACT will be cancelled. Damage by improper use

or mishandling is not covered by the SERVICE CONTRACT.

4. The SERVICE CONTRACT is issued to you as the original purchaser. To protect you from misrepresentation this contract cannot be transferred to a second owner.
5. For your protection McIntosh selects only dealers who have technical competence to guide purchasers fairly, and provide service when necessary. To receive the SERVICE CONTRACT your purchase must be made from a McIntosh franchised dealer.
6. Your completely filled in application for a SERVICE CONTRACT must be postmarked within 30 days of the date of purchase of the instrument.
7. To receive the SERVICE CONTRACT all information on the application must be filled in. The SERVICE CONTRACT will be issued when the completely filled in application is received at McIntosh Laboratory Incorporated in Binghamton, New York.

How to Connect

INPUT

STEREO OR TWIN AMPLIFIER OPERATION

Use shielded cables to connect the signal from the pre-amplifier or signal source to the power amplifier input. To minimize the possibility of hum the shielded cables should be run parallel to each other or loosely twisted together. Locate the cables away from speaker leads and AC power cords. All connections are made on the back panel of the MC 2120.

For stereo operation, the left output of the preamplifier should be plugged into the Left input jack of the power amplifier. The right output of the preamplifier should be plugged into the Right (MONO) input jack of the power amplifier.

For twin amplifier operation a separate signal source can be connected to each input. In stereo or twin amplifier operation the MODE SWITCH must be in the STEREO position.

MONOPHONIC OR SINGLE CHANNEL OPERATION

A shielded cable from the signal source is plugged into the Right (MONO) input lack of the MC 2120 only. The MODE SWITCH on the back panel of the amplifier must be placed in the MONO position. In the MONO position the right channel input jack connects to both left and right power amplifiers. The Left INPUT is disconnected. Only the signal fed into the Right (MONO) input will be amplified.

Mono output is obtained by strapping both outputs in parallel. Should the MODE SWITCH be left in the STEREO position and the output transformers remain strapped for a monophonic load, one channel will attempt to drive the other which causes high circulating currents and overheating. Be certain that the MC 2120 is never operated in the stereo mode with the outputs connected for monophonic operation.

OUTPUT

Be certain the loudspeakers connected to the MC 2120 are capable of handling the power output of the amplifier.

For multiple speaker operation, run separate leads from each speaker to the amplifier. Because of the high power

available from the MC 2120, be sure to use large diameter speaker leads. In all cases, the leads to and from the speaker should be twin conductor or twisted together. Use lamp cord, bell wire, or wire with similar type of insulation to connect the speakers to the amplifier. When using 8 ohm speakers and for the normally short distances of under 30 feet between the amplifier and speaker, #18 wire or larger can be used. For distances over 30 feet between the amplifier and speaker use larger diameter wire. Select the correct size wire for the wire distance from the chart. It is recommended that the DC resistance of the speaker leads not be over 5% of the speaker impedance. Up to 10% can be tolerated. Resistance of the leads should be computed for the length of wire both to and from the speaker or speakers.

Wire Gauge	MAXIMUM WIRE LENGTHS					
	For 4 Ohm Load		For 8 Ohm Load		For 16 Ohm Load	
	Feet	Meters	Feet	Meters	Feet	Meters
22	6	1.83	12	3.66	24	7.32
20	10	3.05	20	6.10	40	12.20
18	15	4.57	30	9.14	60	18.30
16	25	7.62	50	15.24	100	30.50
14	40	12.19	80	24.38	160	48.80
12	60	18.29	120	36.58	240	73.20
10	100	30.48	200	60.96	400	122.00

Wire lengths above represent the wire resistance equal to 5% of the speakers impedance. Use of smaller wire sizes will produce more resistance which causes more power loss and less loudspeaker damping.

STEREO OR TWIN AMPLIFIER OPERATION

Check the impedance of the speaker which is usually identified on the speaker itself or in the speaker owner's manual. Connect a lead from the common terminal of the left speaker to the amplifier LEFT OUTPUT terminal strip COMMON screw. Connect another lead from the other terminal of the left speaker to the screw with the number corresponding to the speaker impedance on the LEFT OUTPUT terminal strip. The right channel speaker is connected in the same manner on the RIGHT OUTPUT terminal strip. For stereo or twin channel operation it is not necessary to use the same impedance loudspeaker on each output. Connect each channel for the impedance desired. Full power will be delivered to each properly connected speaker.

When multiple speakers are to be connected to either or both outputs, the combined load impedance must be calculated. The load must be connected to the appropriate impedance tap. Use this table to aid in selecting the correct impedance match:

Load impedance in ohms	Connect for	Load impedance in ohms	Connect for
1.6 to 3.2	2 ohm output	6.4 to 13	8 ohm output
3.2 to 6.4	4 ohm output	13 and up	16 ohm output

If a load impedance is used that is lower than the output impedance tap, then reduced power and possible distortion will result. If a load impedance is used that is higher than the output impedance tap, then neither the signal nor the amplifier will be harmed but the power available is limited.

FOR STEREO OR TWIN AMPLIFIER CONSTANT VOLTAGE OPERATION:

For output voltage of	Connect for
25 volts	8 ohms

MONOPHONIC OR SINGLE CHANNEL OPERATION

When the MC 2120 is used as a monophonic or single channel power amplifier the two channels are combined to produce output up to 240 watts. The outputs must be tied together at the appropriate load impedance tap. In connecting a load to the MC 2120 for single channel operation connect the common side of the load to the LEFT CHANNEL OUTPUT terminal marked COM., the other lead is connected:

If the speaker or load impedance is	The hot side of the line is connected to	Connect a jumper wire between
1 ohm	Left 2	Left 2 and Right 2
2 ohms	Left 4	Left 4 and Right 4
4 ohms	Left 8	Left 8 and Right 8
8 ohms	Left 16	Left 16 and Right 16

Do not connect unequal impedance taps together

If the load impedance is between any of the above figures, select the best impedance match from;

Load impedance in ohms	Connect for	Load impedance in ohms	Connect for
0.8 to 1.6	1 ohm output	3.2 to 6.4	4 ohm output
1.6 to 3.2	2 ohm output	6.4 and up	8 ohm output

FOR MONOPHONIC CONSTANT VOLTAGE LINE OPERATION;

For output voltage of	Connected for
25 volts	4 ohm output (mono)

For multiple speaker operation, run separate leads from each speaker to the amplifier.

Should the MODE SWITCH be left in the STEREO position and the output transformers be strapped for a monophonic load, one channel will attempt to drive the other and cause circulating currents and overheating. Be certain that the MC 2120 is never operated in the stereo mode with the outputs connected for monophonic operations.

AC POWER

The MC 2120 operates on 120 volts 50/60 Hz. The auxiliary AC OUTLET on the MC 2120 is not fused or switched.

Stereophonic Connections

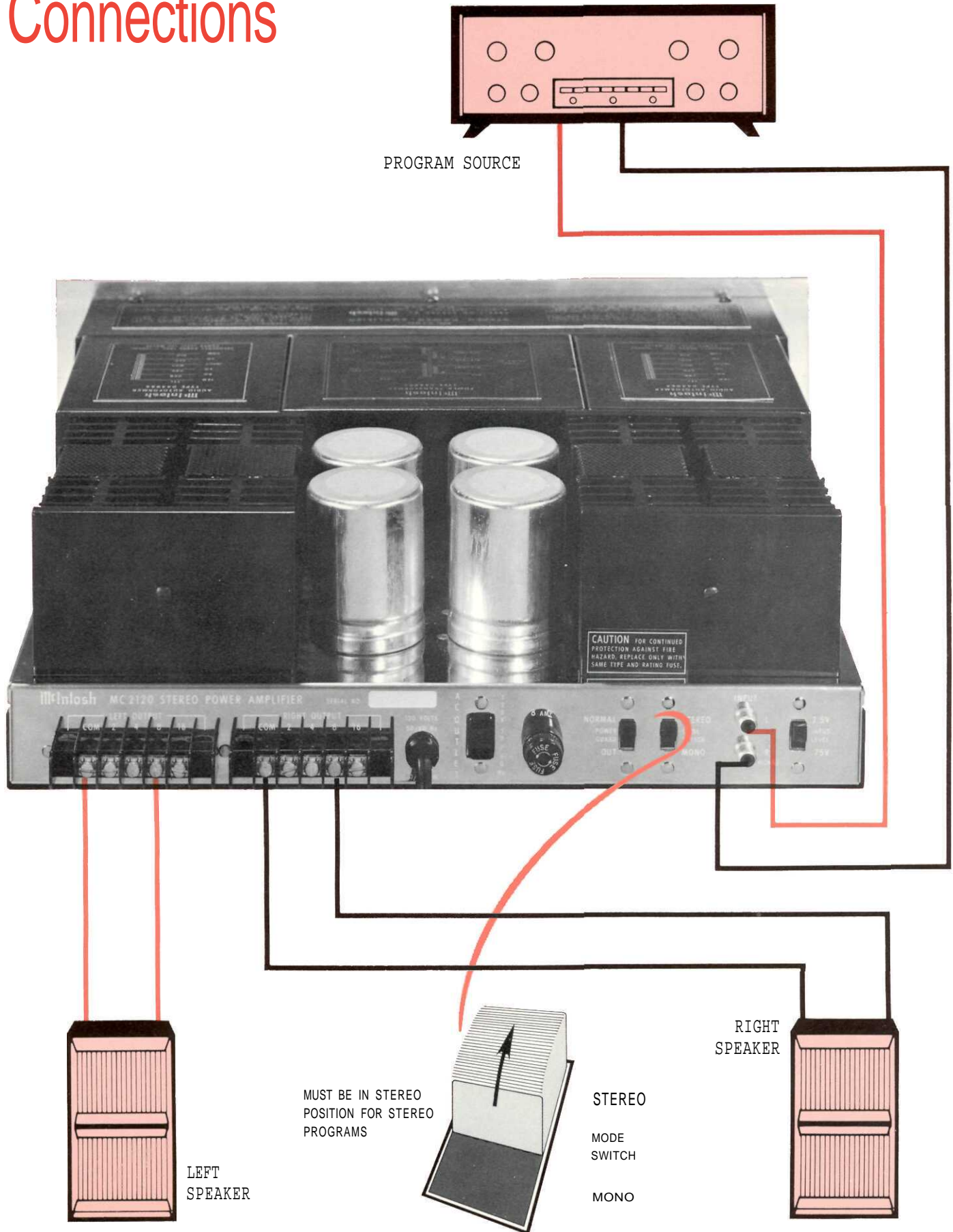

Monophonic Connections

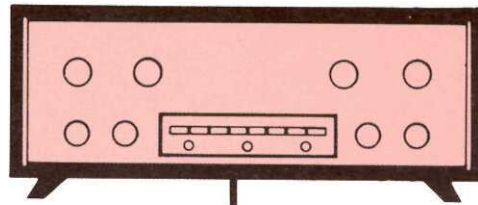

PROGRAM SOURCE

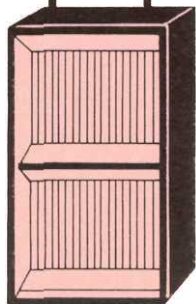
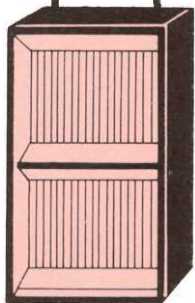

CONNECT FOR MONO USE
ONLY WHEN THE MODE
SWITCH IS IN MONO POSITION

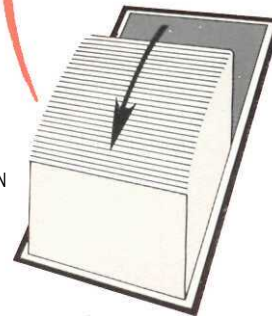

STEREO

MODE
SWITCH

MONO

Front Panel Information



LEFT GAIN

Use the LEFT GAIN control to adjust the volume in the left channel to the desired listening level. Turn the control clockwise to increase the volume.

RIGHT/MONO GAIN

Use the RIGHT/MONO GAIN control to adjust the volume in the right channel to the desired listening level. Turn the control clockwise to increase the volume.

MONO

With the output of MC 2120 connected for monophonic operation and the rear panel MODE SWITCH in MONO the volume is controlled by the RIGHT/MONO GAIN control only.

LIMIT/NORMAL

The NORMAL (green) and LIMIT (red) indicators are a new McIntosh development. As long as the amplifier operates without overload the NORMAL indicator illu-



minates. A waveform comparator in the MC 2120 constantly compares the amplifier input and output waveform. Waveform difference of the output wave is converted to a voltage which is used as a control signal to "turn off" the NORMAL indicator and to "turn on" the LIMIT indicator. The LIMIT indicator turns on whenever the waveform difference exceeds 0.5%. Generally, these waveform differences are the result of applying voltages at the input in excess of its rating. Because the limit indicator circuit can show an overload condition as short as one cycle of a 20,000 Hz signal a holding circuit keeps the red indicator on long enough for the eye to see.

HEADPHONES

The output of the front panel HEADPHONE jack has been designed to feed low impedance dynamic stereo headphones. Electrostatic headphones generally require higher power than dynamic headphones. Connect them to the LEFT and RIGHT OUTPUT contacts on the back of the MC 2120.

Plug dynamic headphones into the front panel HEADPHONE jack. Adjust the front panel LEFT GAIN and RIGHT/MONO GAIN control for comfortable headphone listening.

POWER

The power switch turns the MC 2120 ON or OFF. The switch does not control the power outlet on the back panel. If you wish to control the AC power from a preamplifier control center leave the switch in the ON position. Be sure the AC cord of the MC 2120 is plugged into the controlled outlets on the rear of the preamplifier control center.

OFF: In the OFF position the AC power to the amplifier is turned off.

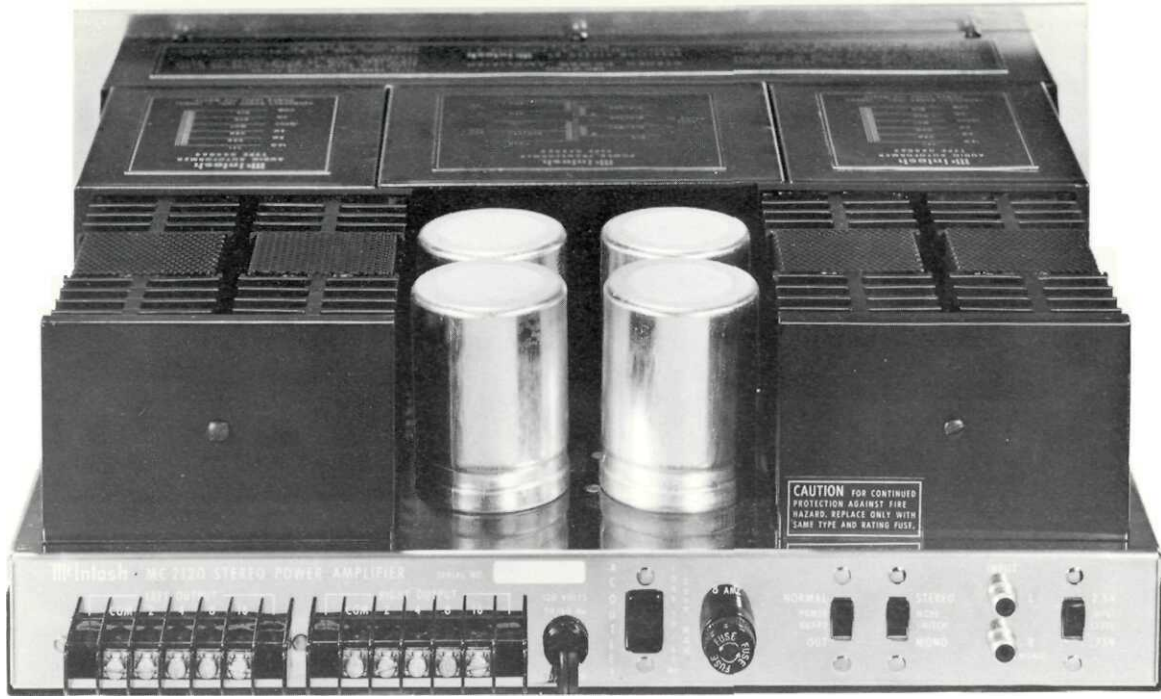

Rear Panel Information

LEFT and RIGHT OUTPUT

For stereo operation, output impedances of 2, 4, 8 and 16 ohms have been provided on a secure, screw type barrier strip. For monophonic operation proper interconnection provides, 1, 2, 4 and 8 ohms from the same barrier strips.

POWER GUARD

Amplifiers are capable of delivering large quantities of power when they are driven to clipping. Clipping is caused when the amplifier is asked to produce more power output than it can deliver with low distortion. A clipped amplifier can have more than 40% harmonic distortion. The extra energy content of the clipped signal will damage most speakers. A new McIntosh advancement helps to protect your speaker from this kind of damage. The MC 2120 has a built in "waveform comparator" that compares the wave shape of the input signal with the output signal. If the non-linearity between the two signals exceeds 0.5% a front panel signal illuminates in red (LIMIT). With the POWER GUARD switch in the NORMAL position, 1.0% distortion will cause the POWER GUARD circuit to operate. The POWER GUARD circuit limits the input dynamically so that the amplifier cannot be overdriven. This eliminates amplifier output clipping. Recommended operations is with the POWER GUARD switch in the NORMAL position at all times.

MODE SWITCH

The MC 2120 can be used in these different manners: stereo (or as a twin amplifier) and mono. Because of the excellent channel separation of the MC 2120, it can

all of these functions. When the instrument is properly connected the MODE switch is used to select the method of operation desired.

INPUT

In the stereo or twin amplifier mode of operation both input jacks accept signal. In the mono mode of operation the Left channel input jack is disconnected and only the Right (MONO) channel input jack accepts signal.

INPUT LEVEL

The input sensitivity of the MC 2120 is 0.75 volts or 2.5 V depending on the position of the INPUT LEVEL switch. With indicated voltage applied and the GAIN control clockwise, the amplifier will deliver its rated power. All McIntosh preamplifiers have been designed to deliver 2.5 volts output with rated input. For the best signal to noise ratio when using McIntosh source equipment, always have the INPUT LEVEL switch in the 2.5 V position and the front panel LEFT and RIGHT/MONO GAIN controls in the fully clockwise position. If more gain is desired the 0.75 V position may be used. For source equipment other than McIntosh set the switch in the position nearest to the stated output rating of the source equipment.

AC POWER

The MC 2120 is rated for 120 volts, 50/60 hertz. It uses 50 watts when there is no signal output and 460 watts with both channels delivering rated power. An 8 ampere fuse protects the MC 2120 electrically. An auxiliary AC power outlet has been provided. The auxiliary outlet is neither fused nor switched.

Performance Limits and Ratings

PERFORMANCE GUARANTEE

Performance Limits are the maximum deviation from perfection permitted for a McIntosh instrument. We promise you that the MC 2120 you buy must be capable of performance at or exceeding these limits or you get your money back. McIntosh is the only manufacturer that makes this guarantee.

PERFORMANCE

McIntosh audio power ratings are in accordance with the Federal Trade Commission Regulation of November 4, 1974 concerning power output claims for amplifiers used in home entertainment products.

POWER OUTPUT

STEREO

120 watts minimum sine wave continuous average power output per channel, both channels operating into 2 ohms, 4 ohms, 8 ohms, or 16 ohms load impedance, which is:

15.5 volts RMS across 2 ohms

21.9 volts RMS across 4 ohms

31.0 volts RMS across 8 ohms

43.8 volts RMS across 16 ohms

MONO

240 watts minimum sine wave continuous average power output into 1 ohm, 2 ohms, 4 ohms, or 8 ohms load impedance, which is:

15.5 volts RMS across 1 ohm

21.9 volts RMS across 2 ohms

31.0 volts RMS across 4 ohms

43.8 volts RMS across 8 ohms

OUTPUT LOAD IMPEDANCE

STEREO

2 ohms, 4 ohms, 8 ohms, and 16 ohms; separate terminals are provided for each output

MONO

1 ohm, 2 ohms, 4 ohms, and 8 ohms; obtained by connecting together the appropriate terminals of both channels

RATED POWER BAND

20 Hz to 20,000 Hz

TOTAL HARMONIC DISTORTION

STEREO

0.1% maximum harmonic distortion at any power level from 250 milliwatts to 120

watts per channel from 20 Hz to 20,000 Hz, both channels operating

MONO

0.1% maximum harmonic distortion at any power level from 250 milliwatts to 240 watts from 20 Hz to 20,000 Hz

INTERMODULATION DISTORTION

STEREO

0.1% maximum if instantaneous peak power output is 240 watts or less per channel with both channels operating for any combination of frequencies, 20 Hz to 20,000 Hz

MONO

0.1% maximum if instantaneous peak power output is 480 watts or less for any combination of frequencies, 20 Hz to 20,000 Hz

FREQUENCY RESPONSE (at one watt output)

20 Hz to 20,000 Hz, +0 -0.25 dB

10 Hz to 100,000 Hz +0 -3.0 dB

NOISE AND HUM

95 dB below rated output

RATINGS

OUTPUT VOLTAGES

25 volts for distribution lines

DAMPING FACTOR

STEREO

16 at 2 ohms output, 50 at 4 ohms output, 20 at 8 ohms output, 14 at 16 ohms output

MONO

16 at 1 ohm, 50 at 2 ohms, 20 at 4 ohms, and 14 at 8 ohms output

INPUT IMPEDANCE

100,000 ohms

INPUT SENSITIVITY

Switchable: 0.75 volt or 2.5 volts—Level control provided for higher input voltages.

GENERAL INFORMATION

POWER REQUIREMENTS

120 volts 50/60 Hz, 50 watts at zero signal output, 460 watts at rated output

SEMICONDUCTOR COMPLEMENT

39 silicon transistors

24 silicon rectifiers and diodes

2 integrated circuits

MECHANICAL INFORMATION

SIZE

Front panel measures 16 inches wide (40.7 cm) by 5 7/32 inches high (13.2 cm). Chassis measures 14 5/8 inches wide (37.2 cm) by 5 inches high (12.7 cm) by 13 inches deep (33 cm), including connectors. Knob clearance required is 1 1/2 inches (3.8 cm) in front of mounting panel

FINISH

Front panel is anodized gold. Chassis is chrome and black

WEIGHT

57 pounds (25.9 kg) net, 70 pounds (31.8 kg) in shipping carton

Performance Charts

Per Channel Both Channels Operating

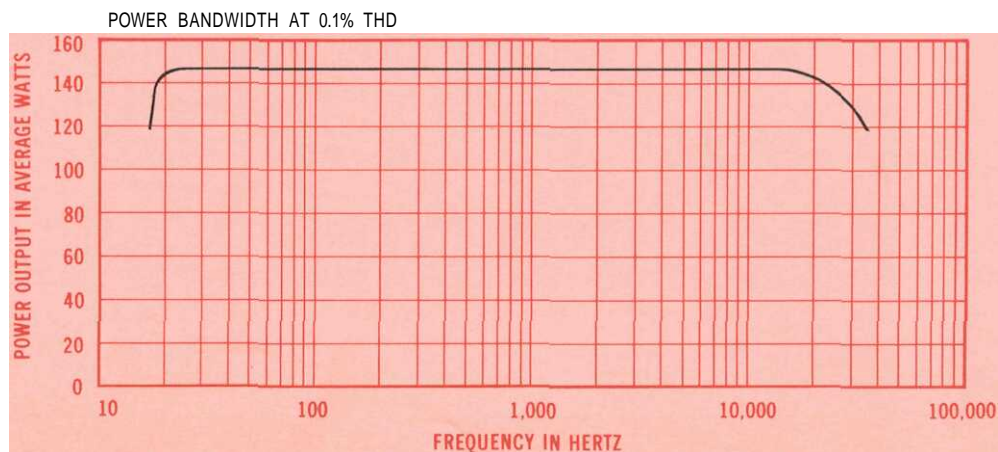
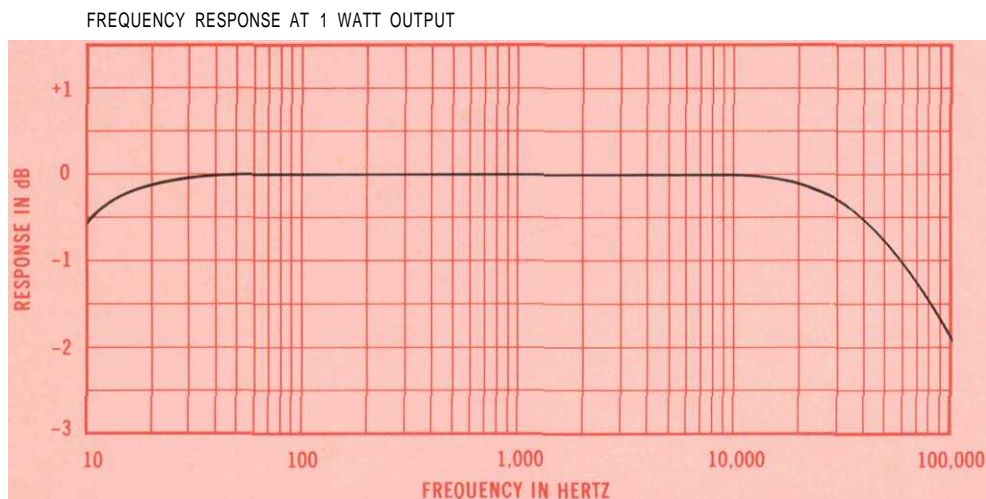
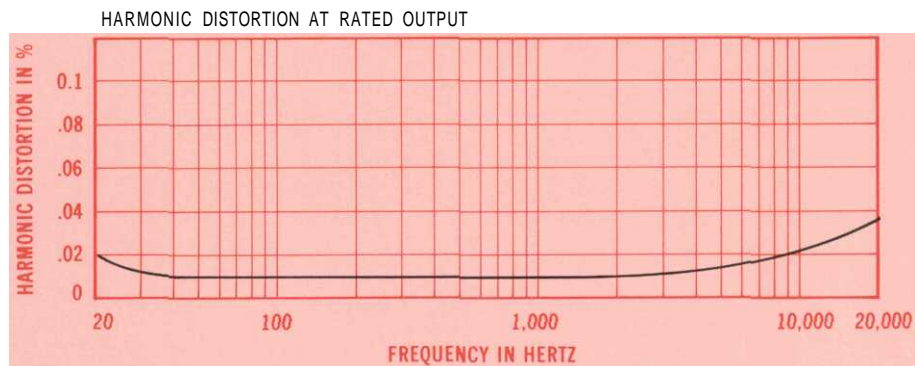

OUTPUT SIGNAL WAVEFORM SHOWING ACTION OF POWER GUARD TO ELIMINATE OUTPUT SIGNAL CLIPPING. AMPLIFIER INPUT IS OVERDRIVEN BY 20 dB FOR BOTH OSCILLOGRAM TRACES.

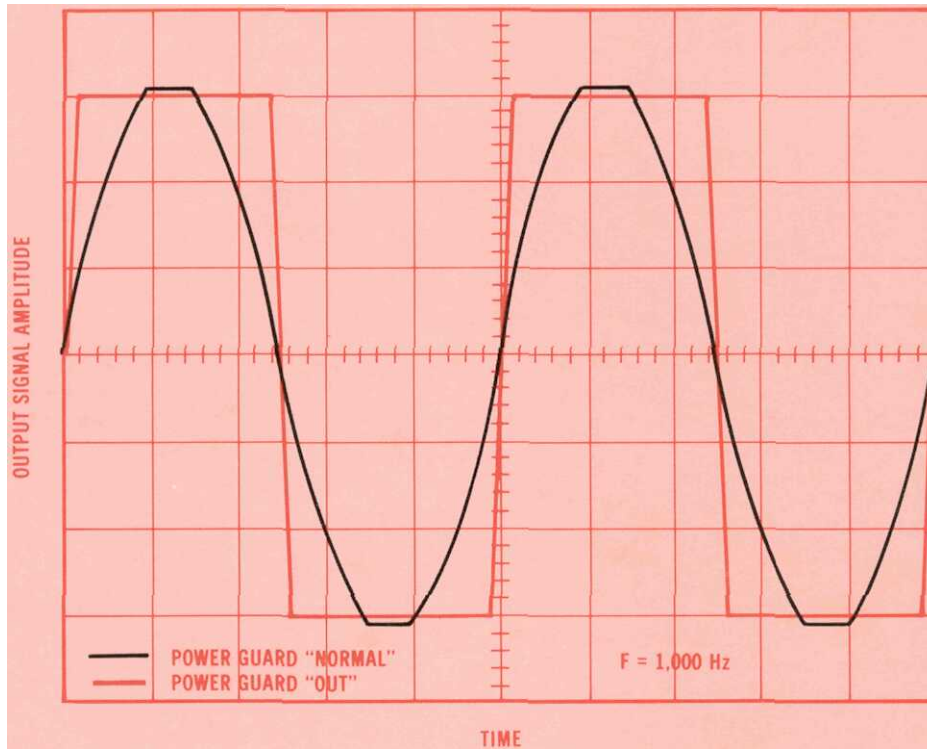

INTERMODULATION DISTORTION VS. POWER OUTPUT

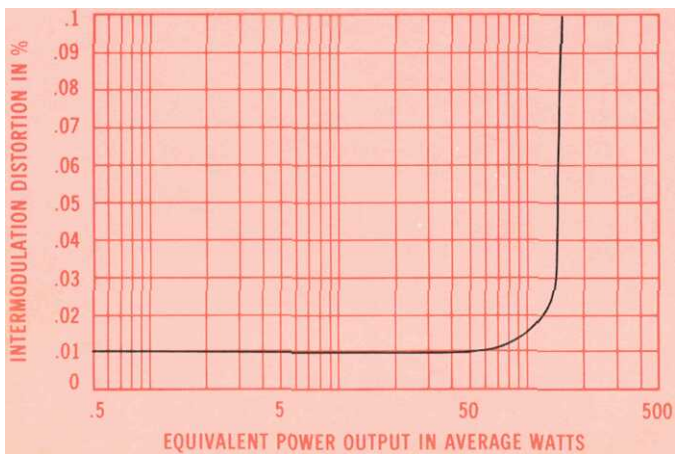

HARMONIC DISTORTION VS. POWER OUTPUT

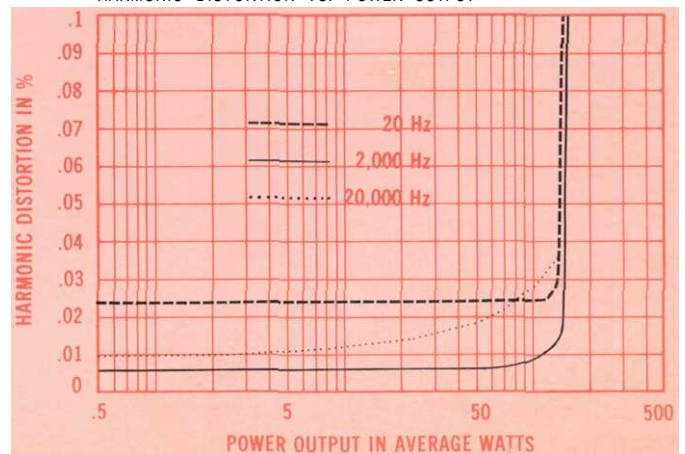

Technical Description

INPUT AMPLIFIER

Separate input amplifiers are used for the right and left channels. Each input amplifier is a two transistor feedback amplifier which has unity gain. They are used to provide high input impedance and low output impedance for driving the power amplifier sections. In addition, impedance matching is provided for the POWER GUARD system input attenuator.

When the MODE selector is switched to MONO, only the right channel input, GAIN control, POWER GUARD attenuator, and input amplifier is used to drive both power amplifiers.

POWER AMPLIFIER

There are two identical power amplifier sections. At the input to each power amplifier is a monolithic differential transistor selected for low noise. The monolithic design yields closely matched transistors for low distortion. The input and the feedback signals are applied to this differential amplifier. The second stage is a class A voltage amplifier using a single transistor with feedback.

The predriver, driver, and output sections follow and are fully complimentary with high efficiency and negligible distortion. The predriver is a complimentary transistor pair biased to nearly class A operation for low crossover distortion. Bias is supplied by a transistor which serves as a temperature tracking circuit so the predriver is properly biased regardless of temperature. The predriver has a generous amount of emitter degeneration for low distortion.

Another complimentary pair of power transistors biased for class AB operation make up the output driver stages. Their bias is developed across a thermistor which holds the bias current stable regardless of temperature.

The output stage consists of 4 rugged complimentary power transistors connected in single ended push-pull parallel. This stage is connected as a balanced emitter follower which allows great stability and low distortion. Due to a unique arrangement of the output bias network, the output transistors are operated class B free of crossover distortion. Heat is not produced by these transistors when there is no output. The bias network for the output stage is temperature compensated assuring class B operation at any temperature or power level.

The output transistors and drivers are mounted on generous sized black anodized aluminum heat sinks. The free flow of room temperature air that passes through the oversized heat sinks provides the cooling necessary for the long life of components.

The MC 2120 has transient free turn on and turn off characteristics. This is because the output of the amplifier is switched by a heavy duty relay to the output autotransformer. The relay is driven by a transistor switch. The control signal to this transistor is derived from a long time constant capacitor charging network. The switch turns on the relay approximately two seconds after the MC 2120 is turned on. The same circuit has a short turn-off time constant which turns off the relay before the amplifier's main power supply has had a chance to drop. The output signal is fed through a matching network to the front panel HEADPHONE jack. The HEADPHONE output is designed to feed low impedance dynamic stereo headphones.

The amplifier output signal is fed to the output terminals through the autotransformer. The McIntosh designed interleaved multifilar wound autotransformer is used to properly match the amplifier to any output impedance tap. The MC 2120 will deliver full power over the entire audio frequency range at any of these impedances. The MC 2120 will not overheat when driving low impedance loads (2 ohms or 4 ohms). The autotransformer also protects speakers from damage in the event of amplifier failure. Should a direct current component appear in the output it is shunted by the autotransformer and cannot damage the speaker.

The McIntosh patented Sentry Monitoring circuit constantly monitors the output signal and instantly reacts to prevent overload of the output transistors. At signal levels up to rated output this circuit has high impedance and has no effect upon the output. If the power output exceeds design maximum, the Sentry Monitoring circuit operates to limit the signal to the output transistors. In the event of a short circuit across the amplifier output or severe impedance mismatch the Sentry Monitoring circuit will protect the output transistors from failure. The positive and negative halves of the output signal are monitored independently.

LIMIT INDICATOR AND POWER GUARD

The front panel NORMAL (green) and LIMIT (red) indicators are activated by a newly designed McIntosh circuit. The MC 2120 has a built in "waveform comparator." The waveform comparator electrically compares the amplifier's output waveform with the input waveform. Should the waveform differences reach 0.5%, the red LIMIT indicator on the front panel is turned on and the NORMAL indicator is turned off. If the differences increase to 1% the POWER GUARD circuit is activated. POWER GUARD provides an unusual margin of safety for loudspeakers by the prevention of amplifier clipping yet permits the amplifier to deliver designed maximum power.

The input waveform and the output waveform are compared in an integrated circuit differential amplifier. Any differences, due to distortion of the output waveform, are converted to a control voltage. This control voltage is applied differentially to a high gain operational amplifier where it is amplified about 100 times. The amplified control voltage is detected by a full wave bridge rectifier then enters a Schmidt trigger which is programmed to sequence the front panel indicators from NORMAL (green) to LIMIT (red) at a preset distortion level. Also built into the trigger circuit is a timing capacitor which holds the LIMIT indicator on long enough to be visible even when the duration of the overload is much shorter. The LIMIT indicator will be illuminated for an overload condition as short as one cycle of a signal at 20,000 Hz.

The same control voltage used to activate the LIMIT indicator also actuates the POWER GUARD system. If the control voltage is greater than is needed to illuminate the LIMIT indication then the POWER GUARD begins operating. The control voltage is used to operate a light emitting diode/light dependent resistor (LDR) network. The LDR is part of an attenuator between the volume control and the input amplifier. The input to the power amplifier can be attenuated to as little as one tenth, if necessary, in order to maintain low distortion in the event of excessive input signal.

The POWER GUARD circuit is activated when the rear panel switch is in the NORMAL position. POWER GUARD protection is disabled in the OUT position. The LIMIT indicator operates regardless of the position of the POWER GUARD switch.



Block Diagram

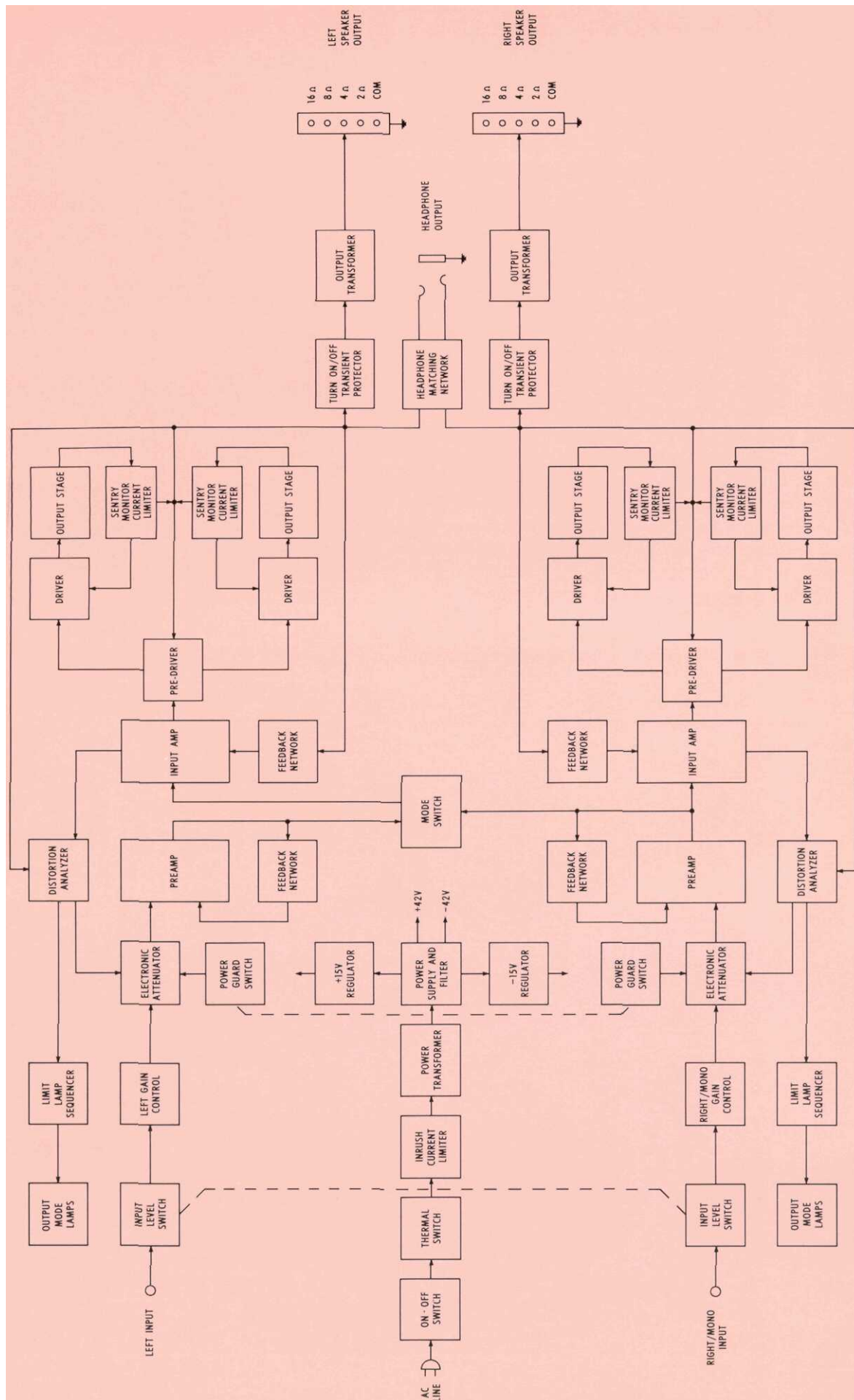

McIntosh

MCINTOSH LABORATORY INC.
2 CHAMBERS ST., BINGHAMTON, N. Y. 13903

607-723-3512

Design subject to change without notice.

Printed in U.S.A.

038-921